

Article number: 204060M1232A0X

Description: E+G levelling foot

GN 40-60-M12-32-A0-X

Note: X With female thread, External hexagon

## Measures

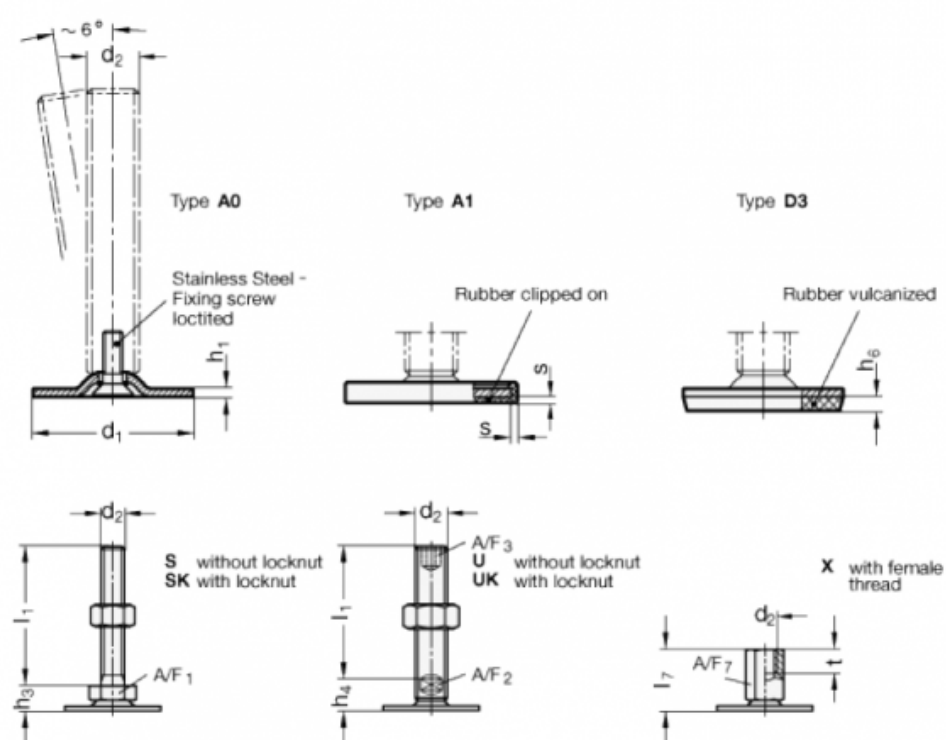

A/F7	=	17
d1	=	60
d2	=	M12
h1	=	2.5
h6	=	
l7	=	32
s	=	
t	=	12